

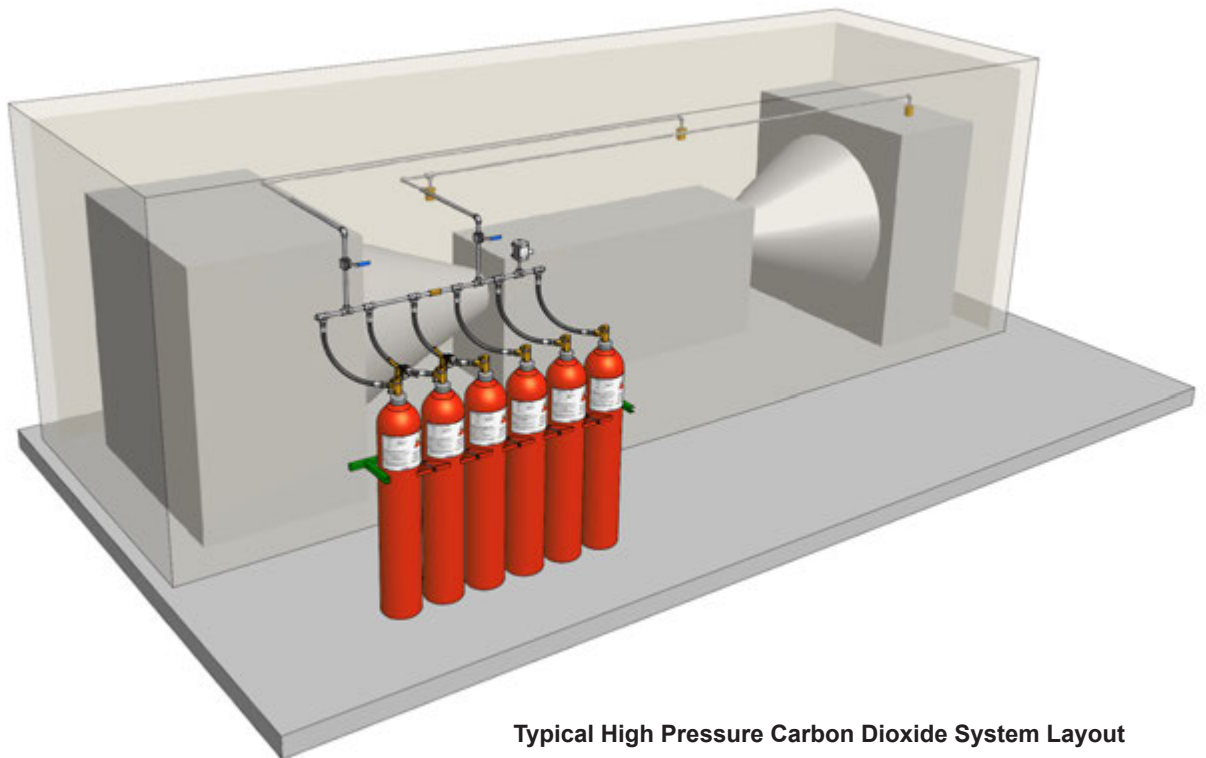

HPCO₂ FIRE EXTINGUISHING SYSTEM

The Janus Fire Systems® HPCO₂ Fire Extinguishing System utilizes highly pressurized carbon dioxide as the extinguishing medium. Carbon dioxide (CO₂) is a dry, inert, non-corrosive fire suppression agent perfectly suited to protect high value assets in normally unoccupied and unoccupiable areas when an electrically non-conductive agent is required and where clean-up of other agents is problematic. Each system consists of the following components and their associated accessories:

1. **HPCO₂ Storage Components** - Storage components consist of the cylinder assembly(s), which contains the liquid CO₂ agent, and the cylinder bracket(s), which holds the cylinder assembly securely in place.
2. **HPCO₂ Distribution Components** - Distribution components consist of the discharge nozzles used to introduce the CO₂ agent into a protected hazard along with the associated piping system used to connect the nozzles to the cylinder assembly.
3. **Trim Components** - Trim components complete the installation of the HPCO₂ system and consist of discharge flex hose, discharge outlet adapters or check valves, actuation flex hose, connection fittings, solenoid valves, and manual valve actuators.
4. **Supplemental Components** - Supplemental components include the discharge pressure switch, inline check valves, selector valves, lockout valves, rupture discs, and regulators. They supplement the core equipment or complete a specific cylinder configuration.
5. **Control Panel** - This device monitors the condition of the solenoid valve, detectors, warning devices, and any manual release stations. All electric or electronic devices must connect to the control panel in order to function.
6. **Early Warning Detection and Alarm Devices** - Early warning detection devices coupled with manual release stations maximize system efficiency while audible and visual alarm devices alert staff of alarm conditions.



Typical High Pressure Carbon Dioxide System Layout



EQUIPMENT DESCRIPTION

The CO₂ agent is stored as a liquid in cylinder assemblies designed specifically for this purpose and pressurized to 850 psi (58.6 bar) at 70°F (21°C). An identification label is affixed to the cylinder body indicating the empty cylinder weight, filled cylinder weight, fill quantity of CO₂, charging pressure, date of fill, and fill station. Except for special temperature conditions, all cylinders are filled to their specified weight. Winterized cylinders are filled to 90% of their capacity with carbon dioxide and then superpressurized with nitrogen to the remaining full capacity in order to prevent cylinder pressure from dropping below 750 psi (51.7 bar) in extremely cold environments. Cylinders are not partially filled.

CO₂ fire extinguishing systems are designed in accordance with National Fire Protection Association (NFPA) 12 - Standard on Carbon Dioxide Extinguishing Systems. CO₂ may be used in a total flooding system where the supply of CO₂ is discharged into a normally unoccupied or unoccupiable enclosed space, filling it to a proper concentration. It also may be used for local applications where the specially designed CO₂ nozzle is arranged to discharge CO₂ directly on the burning material.

The ambient temperature range for cylinders used in total flooding systems is 0°F to 130°F (-18°C to 54°C). For cylinders used in local application systems, the ambient temperature range is 32°F to 120°F (0°C to 49°C).

Nominal Cylinder Size ¹		P/N		Empty Weight		Full Weight		Height (H)		Width (W)	
lb	kg	Standard	Winterized	lb	kg	lb	kg	in	mm	in	mm
50	22.7	19561	20470	96	43.5	146	66.2	55.6	1412	8.5	216
75	34.0	19560	20471	160	72.6	235	106.6	61.1	1552	9.2	234
100	45.4	19559	20472	210	95.3	310	140.6	62.6	1590	10.4	264

¹ Additional sizes available for special orders.

The cylinder assembly is composed of a cylinder, dip tube, and cylinder valve.

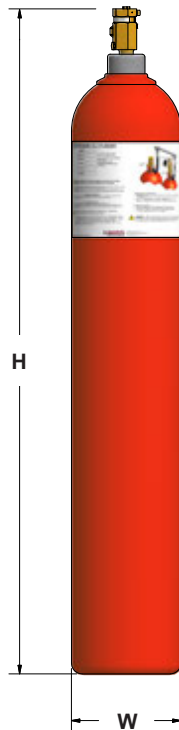

Cylinder Valve: The automatic release of CO₂ is controlled by a forged brass, force differential operated cylinder valve connected to the neck of the cylinder. Each valve assembly is shipped with an anti-recoil safety plug installed in the discharge outlet and a manual actuation safety plug installed in the manual actuation connection. Both safety plugs are chained to the cylinder valve.

Dip Tube: A rigid dip tube is used in all cylinders to ensure liquid discharge.

Cylinder: The seamless cylinder is manufactured according to the requirements of the U.S. Department of Transportation (USDOT) and/or Transport Canada for compressed gas. The cylinder is designed for mounting in a vertical position only.



CYLINDER VALVE w/ DIP TUBE ADAPTOR (P/N 19428)

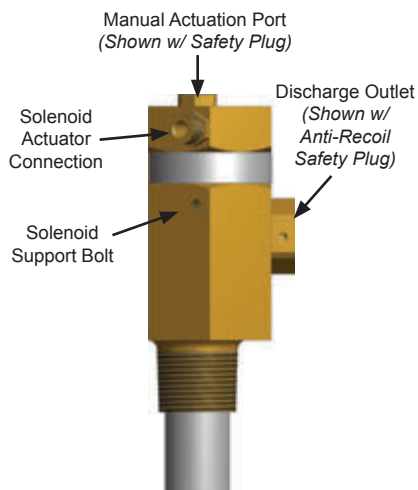

The cylinder valve has five key features:

Manual Actuation Port: A threaded female connection on the top of the primary valve serves as the attachment point for the manual valve actuator. It is shipped with a manual actuation safety plug installed.

Solenoid Actuator Connection: A threaded male connection serves as the attachment point for the solenoid valve.

Solenoid Support Bolt: A bolt located on the side of the cylinder valve directly underneath the solenoid actuator connection is used to connect the solenoid support bar to the valve.

Discharge Outlet: A 1-1/16" threaded female connection serves as the attachment point for the discharge outlet adapter or discharge check valve. It is shipped with an anti-recoil safety plug installed.

Rupture Disc: A rupture disc is affixed to the cylinder valve as an emergency relief device in the event of excessive pressure within the cylinder. Its rupture point is in the range of 2,650 to 3,000 psi (182.7 to 206.8 bar).

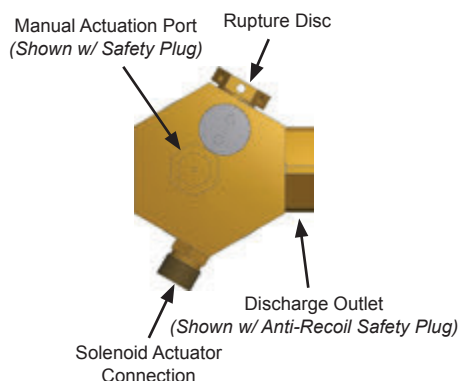

TRIM COMPONENTS

Trim components are required to operate a single HPCO₂ cylinder.

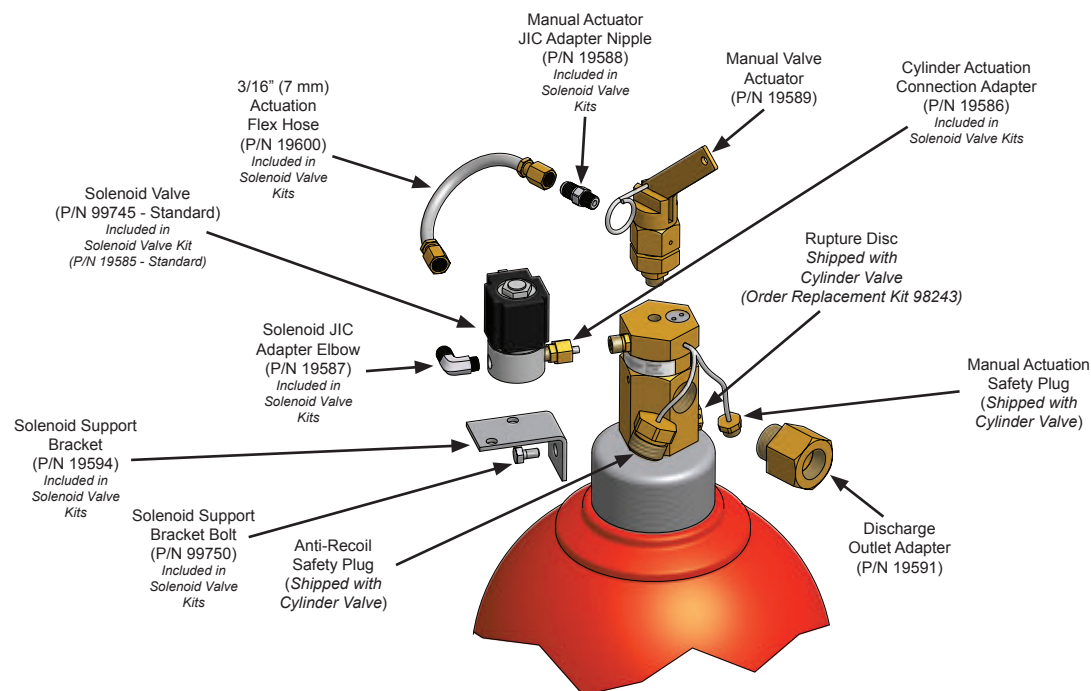

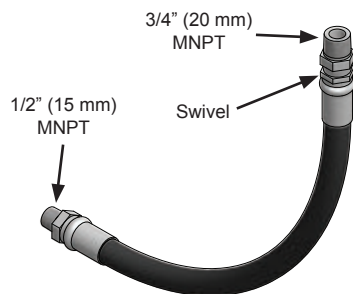

Discharge Flex Hose

A 22 in (559 mm) discharge flex hose is used to connect the cylinder valve outlet to the system manifold and discharge piping. The flexible hose allows for temporary misalignment of the cylinders to ease installation or removal for maintenance. It has a minimum bend radius of 9.5 inches (241 mm). It is shipped with the discharge outlet adapter attached for single cylinder systems (P/N 99707) or the discharge outlet check valve attached for multiple cylinder systems (P/N 99706).

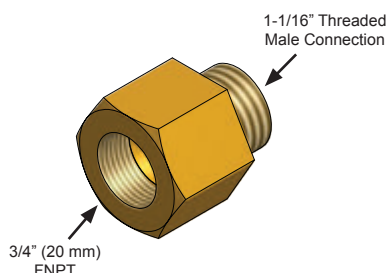

Discharge Outlet Adapter

A 3/4" (20 mm) FNPT discharge outlet adapter threads into the cylinder valve outlet in a single cylinder system. It facilitates the attachment of the discharge flex hose to the cylinder valve. The discharge outlet adapter is shipped attached to the discharge flex hose (P/N 99707). When multiple cylinders share a common manifold, a outlet check valve must be used instead.

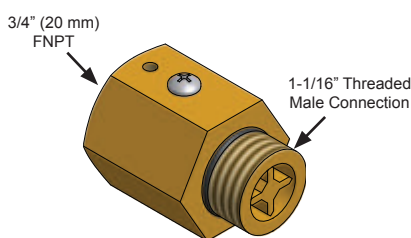

Discharge Outlet Check Valve

A 3/4" (20 mm) FNPT discharge outlet check valve must be threaded into the cylinder valve outlet of each cylinder sharing a common manifold in a multiple cylinder system. When threaded into the valve outlet, the check valve is upset allowing direct back pressure from the discharge manifold to actuate the slave cylinder valves. When a cylinder is removed for service, the check valve remains connected to the discharge flex hose and functions to prevent the backflow of CO₂ agent should accidental discharge occur before the cylinder is replaced. The discharge outlet check valve is shipped attached to discharge flex hose (P/N 99706).

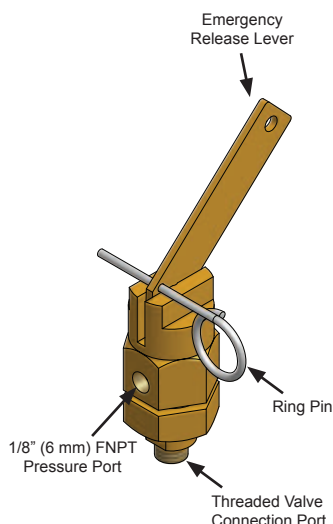

Manual Valve Actuator (P/N 19589)

A manual valve actuator attaches to the manual actuation port on top of the primary cylinder valve and provides a means to manually open the cylinder valve. The manual valve actuator consists of a brass body, emergency release lever, pressure port, and steel safety ring pin.

To discharge the cylinder arrangement manually, the ring pin is removed and the emergency release lever is pulled. This forces the actuation pin to depress the Schrader valve inside the manual actuation port causing pressure above the cylinder valve piston to be vented. Cylinder pressure then raises the piston to open the cylinder valve.

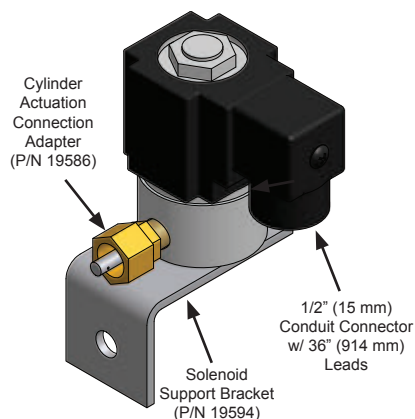

Solenoid Valve Kit (See Chart for P/N)

The solenoid valve attaches to the primary cylinder valve at the solenoid actuator connection via a cylinder actuation connection adapter and is utilized to automatically open the cylinder valve upon receipt of a signal from the control panel or other source. It has a standard voltage of 24 VDC, 10 Watts and enclosure rating NEMA 4X. Orifice size is 1/32 inch (0.8 mm). It has a temperature range of -20°F to 130° F (-29°C to 54°C).

The outlet port of the solenoid valve is connected to the pressure port of the manual valve actuator with 3/16" (7 mm) flexible hose. When energized, the solenoid valve opens allowing pressure from above the main piston of the cylinder valve to vent out through an opening in the manual valve actuator causing the cylinder valve to open.

An optional explosion-proof solenoid is available with an enclosure rating NEMA 4x, 7, and 9. Both the standard and explosion-proof solenoids are available in optional 120 VAC, 50/60Hz voltage or 220 VAC, 50Hz/240 VAC, 60Hz voltage models. All port sizes are identical to the standard model. Valve kits contain all necessary components to install the solenoid valve.

P/N		Voltage	Enclosure Rating
Solenoid Valve Kit ¹	Solenoid Valve		
19585	99745	24 VDC	NEMA 4x
99733	99744	24 VDC	NEMA 4x, 7, and 9
99594	99617	120 VAC	NEMA 4x
99593	99616	120 VAC	NEMA 4x, 7, and 9
99163	99165	220/240 VAC	NEMA 4x
99164	99166	220/240 VAC	NEMA 4x, 7, and 9

¹ All Solenoid Valve Kits include Cylinder Actuation Connection Adapter (19586), JIC Adapter Elbow (19587), Flex Hose (19600), JIC Adapter Nipple (19588), Support Bracket (19594), Support Bolt (99750), 2x Screws (99751), and Lock Washer (99746)

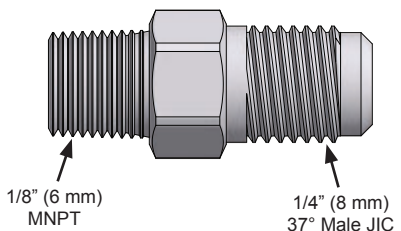

JIC Adapter Nipple (P/N 19588)

A 1/8" (6 mm) MNPT by 1/4" (8 mm) 37° male JIC adapter nipple is threaded into the pressure port of the manual valve actuator to facilitate the connection of actuation flex hose. One adapter nipple is shipped as part of each solenoid valve kit.

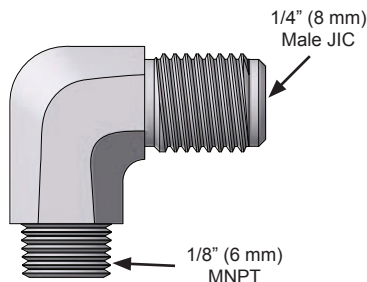

JIC Adapter Elbow (P/N 19587)

A 1/8" (6 mm) MNPT by 1/4" (8 mm) 37° male JIC adapter elbow is threaded into the outlet of the solenoid valve to facilitate the connection of flexible hose. One adapter elbow is shipped as part of each solenoid valve kit.

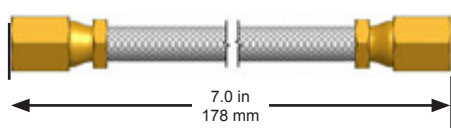

Actuation Flex Hose (P/N 19600)

A 3/16 in (7 mm) Teflon® lined stainless steel wire braided flex hose with 1/4 in (8 mm) 37° female JIC fittings is utilized to connect the solenoid valve outlet port to the pressure port of the manual valve actuator. One length of hose is shipped as part of each solenoid valve kit.



MULTIPLE CYLINDER ARRANGEMENTS

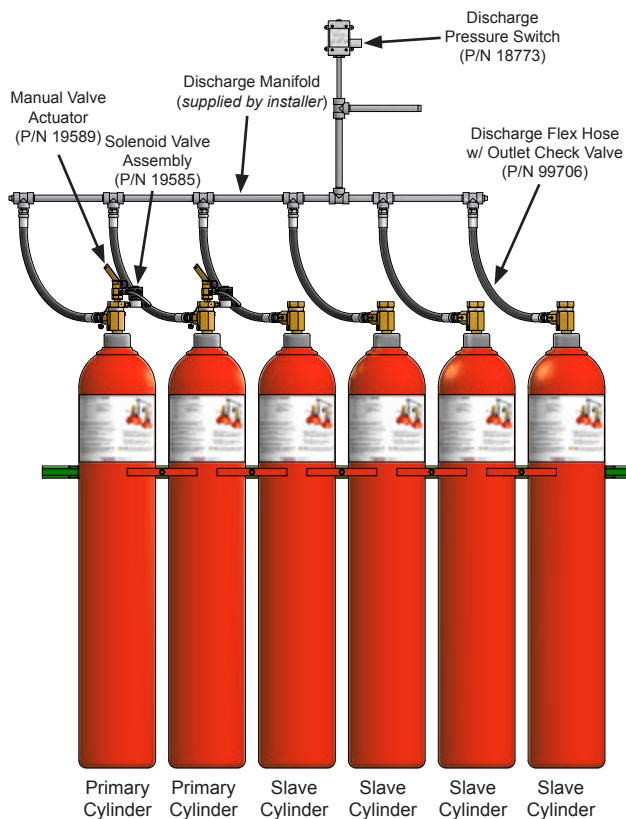

Typical Primary and Slave Cylinder Arrangement

In multiple cylinder arrangements, each primary cylinder is actuated manually or electrically, and then each slave cylinder is actuated by direct back pressure from the discharge manifold.

For cylinder arrangements composed of two cylinders, one primary cylinder is used with one slave cylinder. For cylinder arrangements composed of three or more cylinders, NFPA 12 requires two primary cylinders be used.

Note: The minimum manifold pressure for slave actuation is 500 psi (34.5 bar).

MAIN/RESERVE CYLINDER ARRANGEMENTS

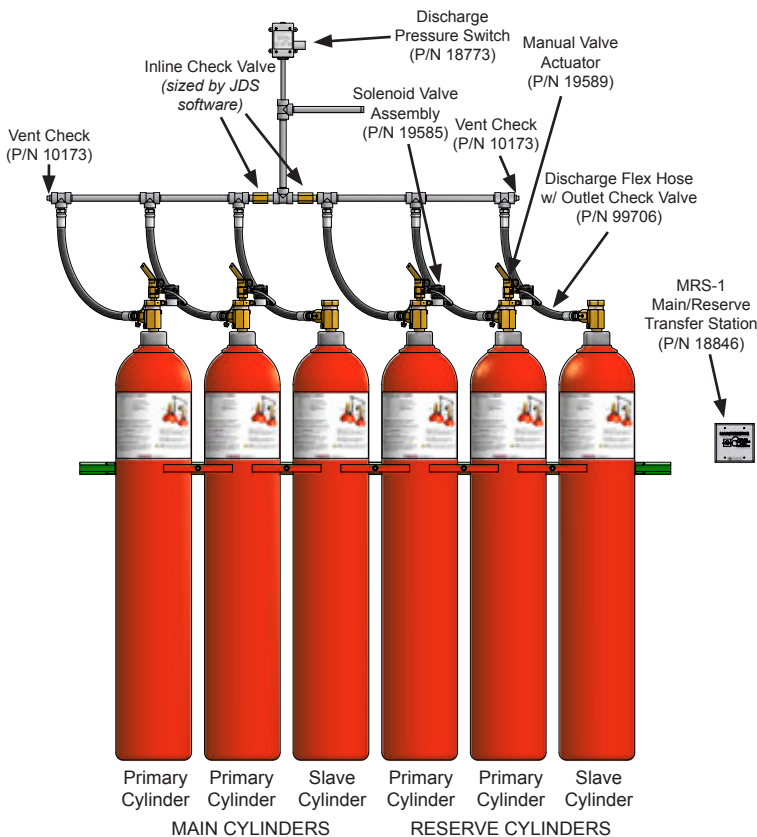

Typical Main/Reserve Cylinder Arrangement

HPCO₂ cylinders may be installed in a main/reserve arrangement. In a main/reserve system, the number of cylinders required to protect a hazard are installed as the main cylinders. A second set of reserve cylinders is installed and connected to the same discharge piping as the main cylinders. This allows for cylinders to be removed for maintenance without taking the HPCO₂ system offline.

Discharge preference is shifted between the main and reserve cylinders using the Janus Fire Systems[®] MRS-1 Main/Reserve Transfer Station (refer to datasheet DS1066).

Inline check valves are implemented in the discharge manifold to prevent the discharge flow of the main cylinders from actuating any reserve cylinder valves or vice versa.



INITIAL/EXTENDED CYLINDER ARRANGEMENTS

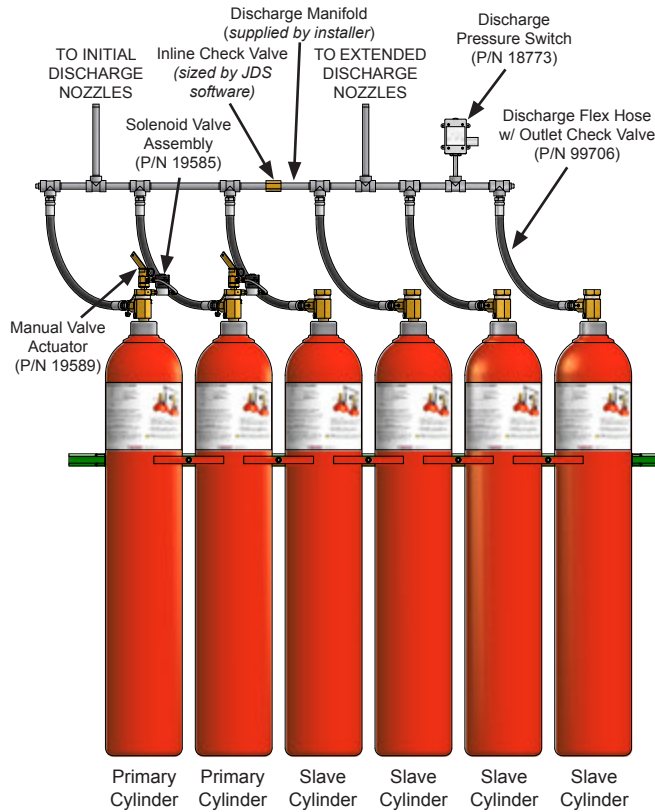

Typical Initial/Extended Cylinder Arrangement

For protecting hazards capable of deep-seated fires, initial / extended cylinder arrangements are implemented. Upon actuation, this arrangement provides an initial discharge to suppress the fire and an extended discharge to prevent the fire from rekindling.

An inline check valve is required in the discharge manifold between the initial discharge cylinders and extended discharge cylinders.

SELECTOR VALVE CYLINDER ARRANGEMENTS

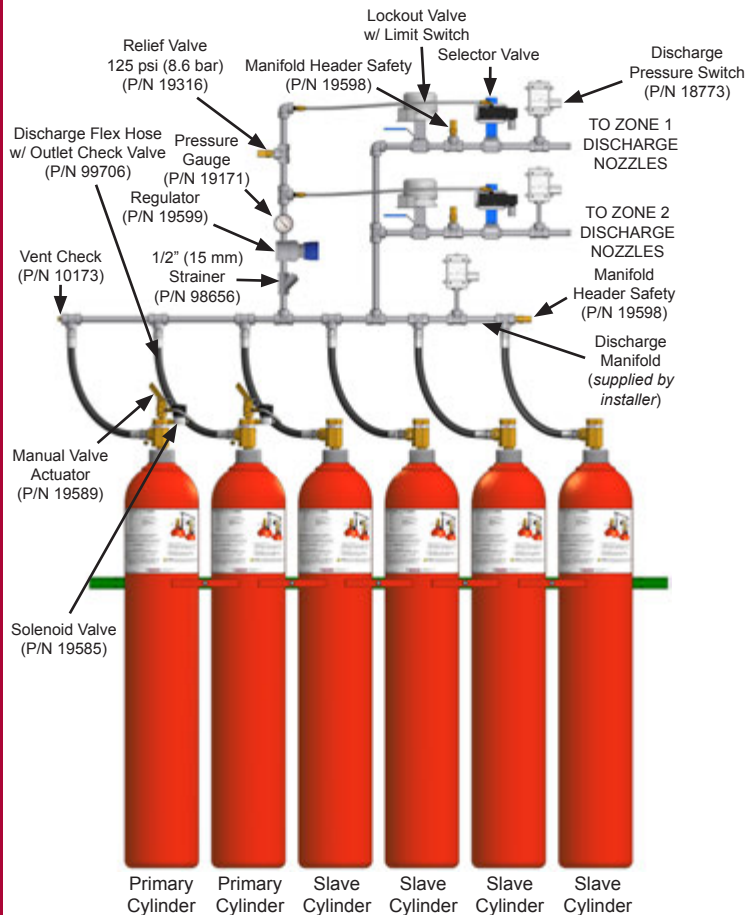

Typical Selector Valve Cylinder Arrangement

Selector valve arrangements are implemented when protecting two or more separate hazards or hazard zones with the same HPCO₂ cylinders. Pneumatically actuated selector valves fitted with solenoid valves are installed between the discharge manifold and discharge nozzles. When the HPCO₂ cylinders are actuated, pneumatic pressure from the discharge manifold is regulated down to 100 psi (6.89 bar) and directed into the solenoid valve inlet ports of each selector valve. Only the solenoid valve electrically actuated by the releasing panel will then allow this pressure to pass through to the selector valve pneumatic actuation port causing that selector valve to open and allow CO₂ discharge into the selected hazard zone.



SELECTOR VALVE W/ TIME DELAY CYLINDER ARRANGEMENTS

NFPA 12 mandates that total flooding CO₂ systems for occupiable enclosures and certain local application systems (refer to NFPA 12, 2008, Section 4.5.6.1) be provided with pneumatic time delays and pneumatic predischarge alarms. This is achieved with the use of a pneumatically actuated selector valve operated by the Janus Fire Systems[®] Pneumatic Pilot Cabinet.

The Pneumatic Pilot Cabinet is normally depressurized. When the HPCO₂ cylinders are actuated, pneumatic pressure from the discharge manifold is regulated down to 100 psi (6.89 bar) and enters the Pneumatic Pilot Cabinet. A solenoid valve within the cabinet is opened by a signal from the releasing panel initiating a pneumatic timer and directing pilot pressure to sound a pneumatic predischarge siren. Upon completion of the predischarge period, the pneumatic timer opens allowing pressure to actuate the pneumatic actuation port of the selector valve, opening the valve and beginning discharge.

Multiple Pneumatic Pilot Cabinets may be implemented with multiple selector valves to allow protection over multiple hazards or hazard zones.

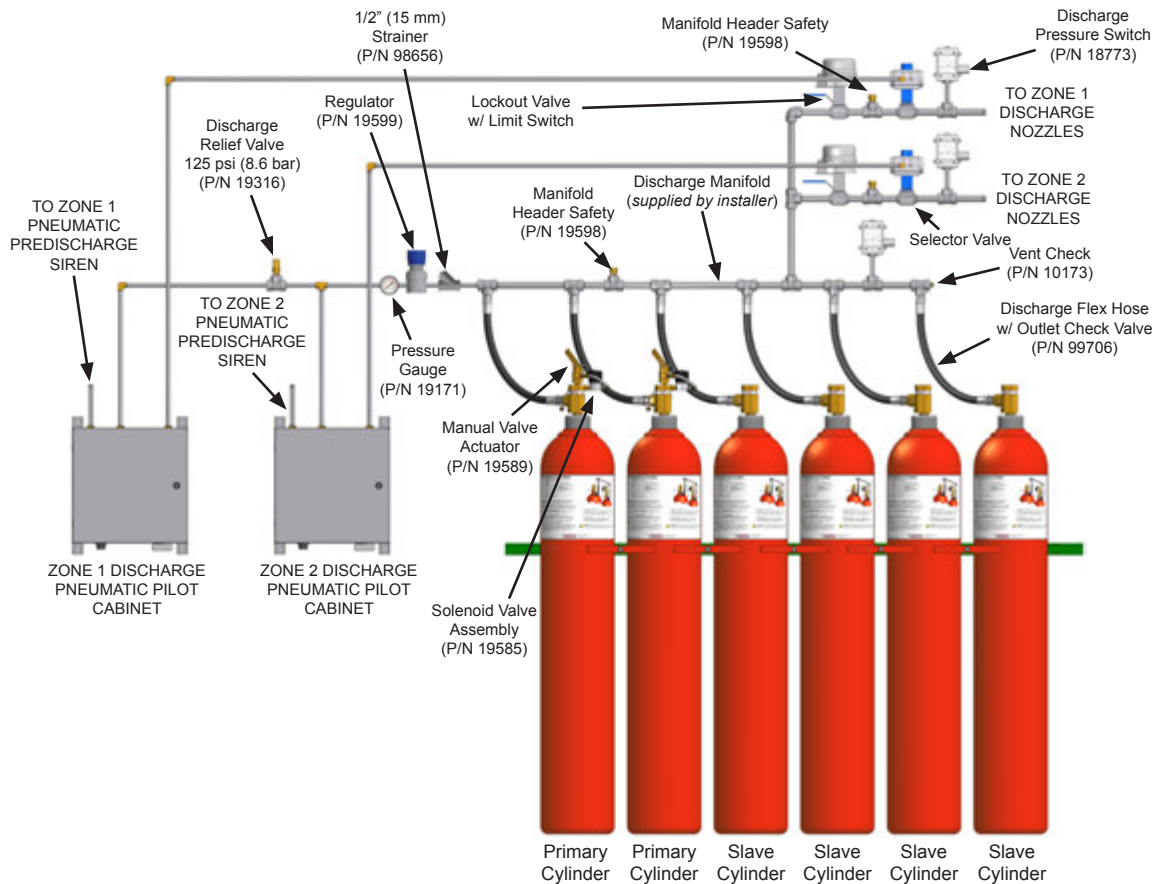

Typical Selector Valve Cylinder Arrangement w/ Pneumatic Time Delay



Enclosure

NEMA 4 & 12 (IP66)
 Dimensions: 20" x 20" x 6"
 (508 mm x 508 mm x 152 mm)
 Ambient Temp: 40° to 130°F
 (4° to 54°C)
 Heater Included

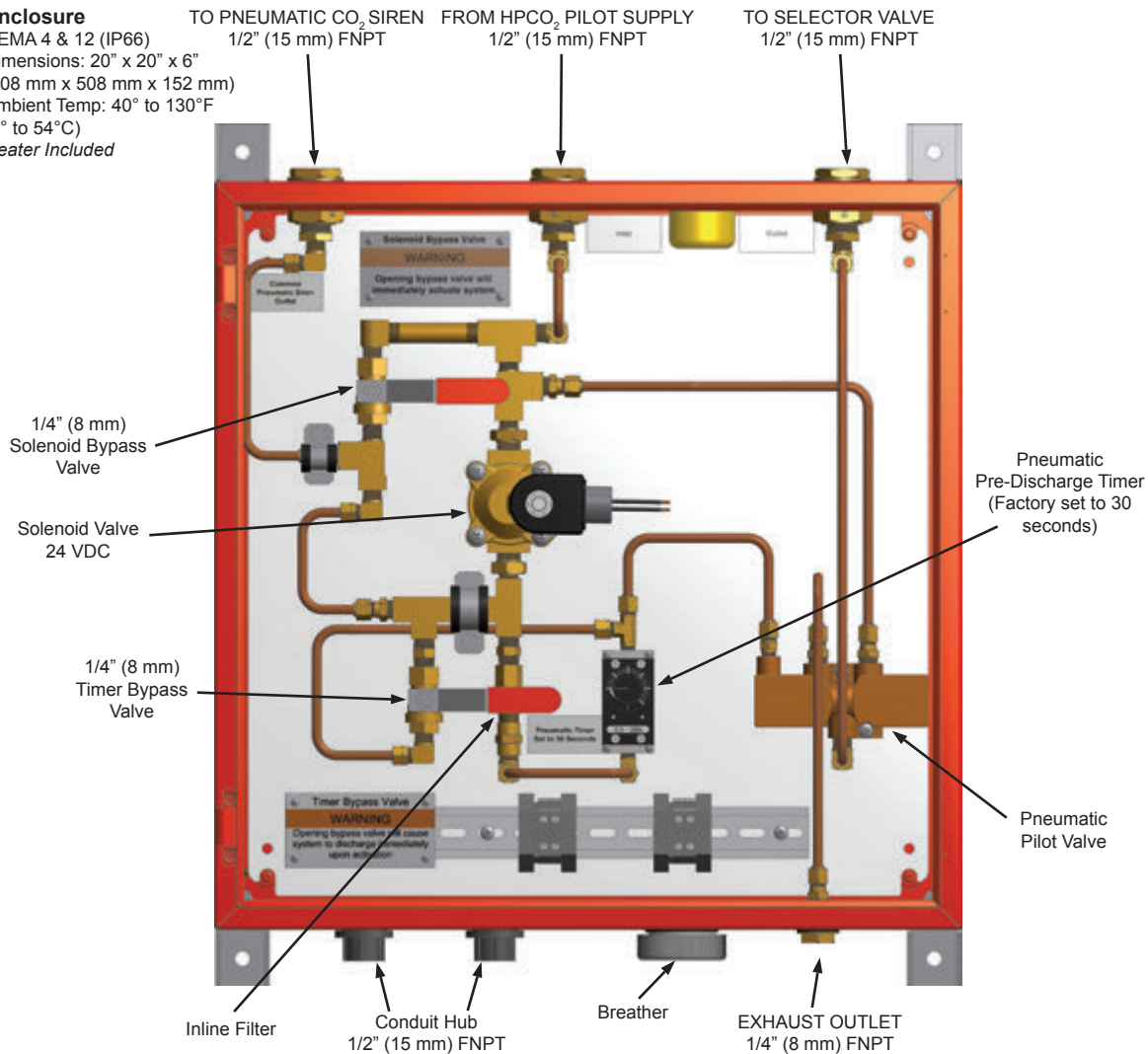

Standard Selector Pilot Cabinet (P/N 99728)

SELECTOR PILOT CABINET IN PRESSURIZED STANDBY CONDITION

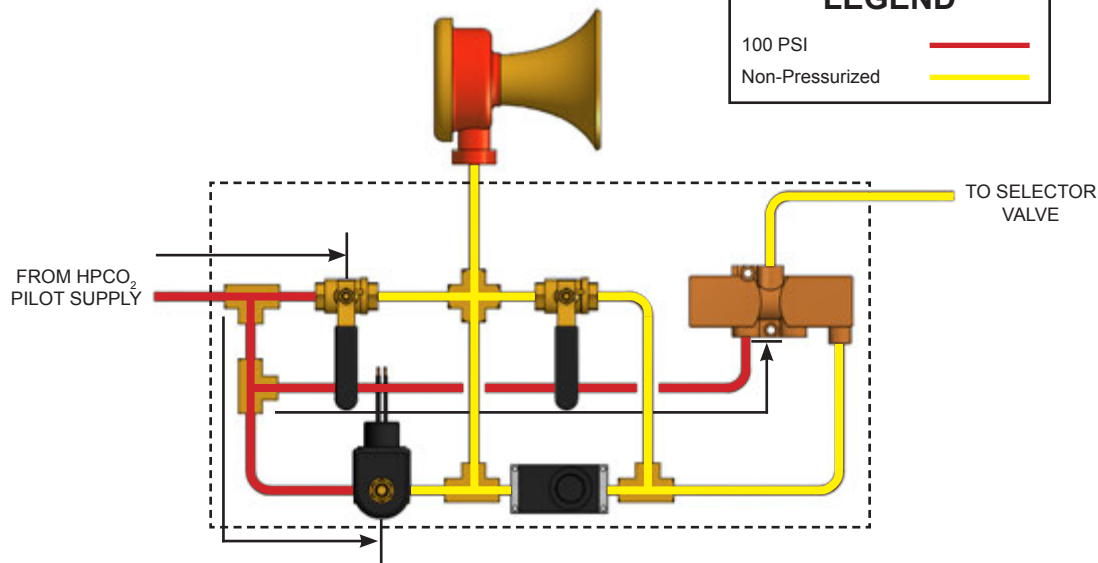

Selector Pilot Cabinet P&ID (Pressurized Standby)

**SELECTOR PILOT CABINET IN
PRE-DISCHARGE CONDITION**

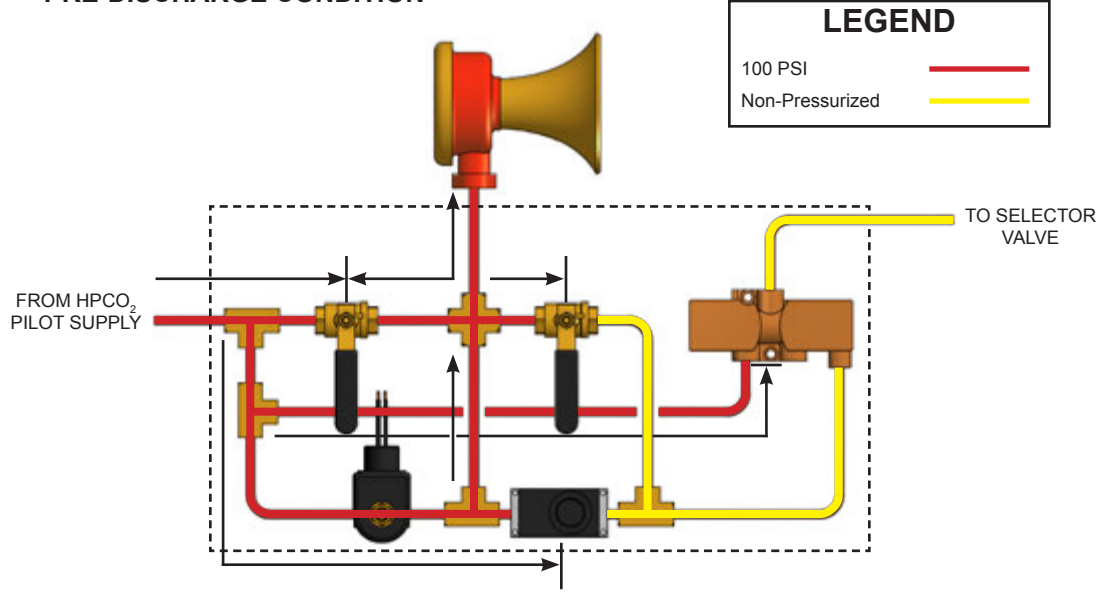

Electrically Actuated Cabinet (Pre-Discharge)

**SELECTOR PILOT CABINET IN
DISCHARGE CONDITION**

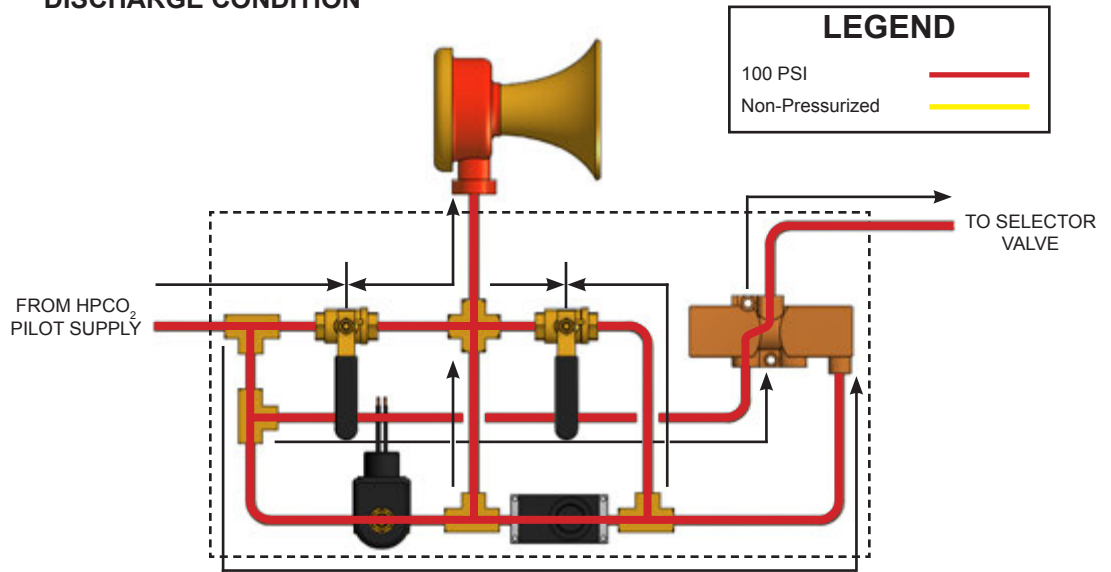

Electrically Actuated Cabinet (Discharge)

SELECTOR PILOT CABINET IN DISCHARGE CONDITION

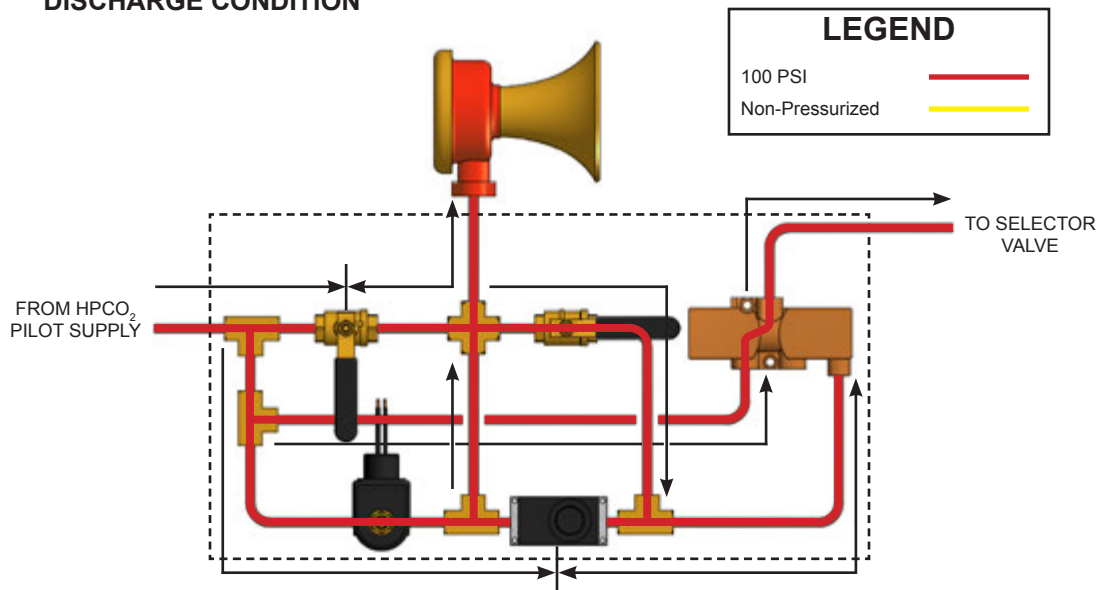

Electrically Actuated Cabinet (Timer Bypass)

SELECTOR PILOT CABINET IN PRE-DISCHARGE CONDITION

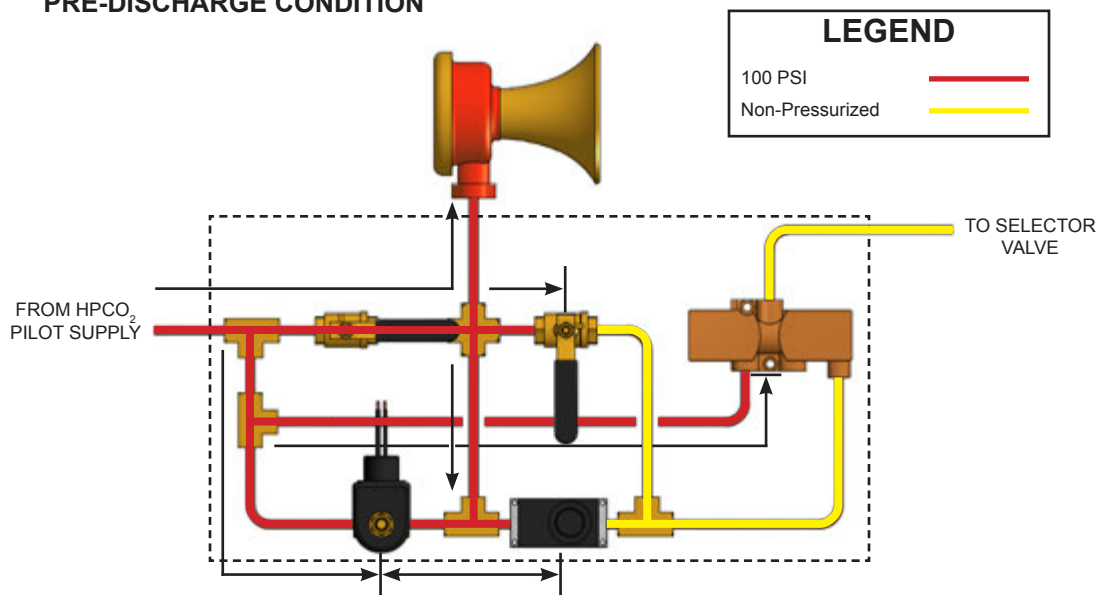

Manually Actuated Cabinet (Pre-Discharge)

Note: The HPCO₂ primary cylinder manual actuators operate independently of the pilot cabinet. Actuation must occur at both locations to manually actuate the system.

SELECTOR PILOT CABINET IN DISCHARGE CONDITION

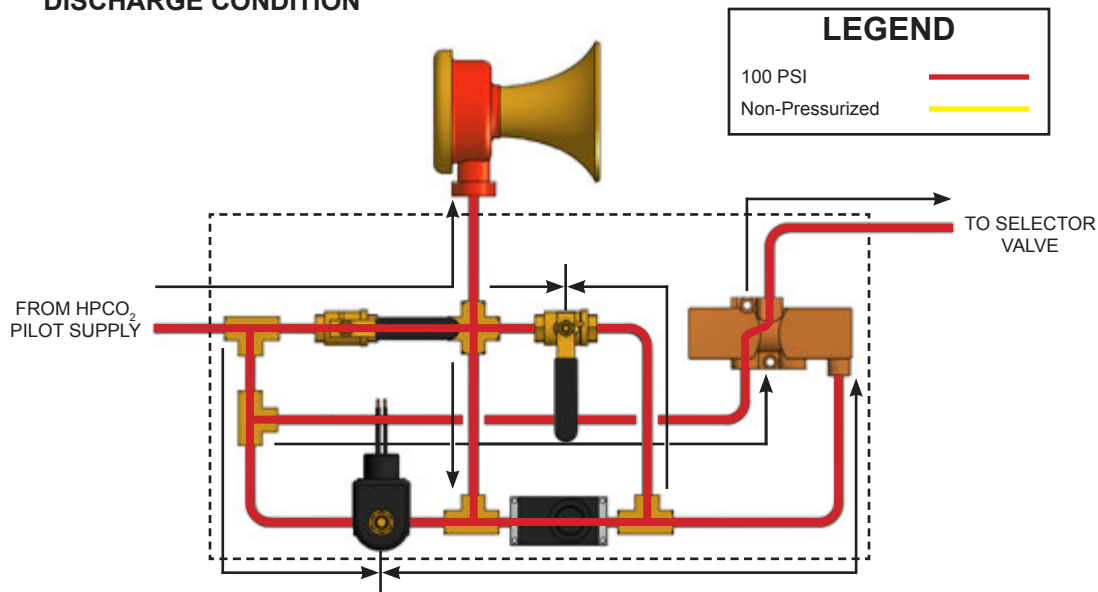

Manually Actuated Cabinet (Discharge)

Note: The HPCO₂ primary cylinder manual actuators operate independently of the pilot cabinet. Actuation must occur at both locations to manually actuate the system.

SELECTOR PILOT CABINET IN DISCHARGE CONDITION

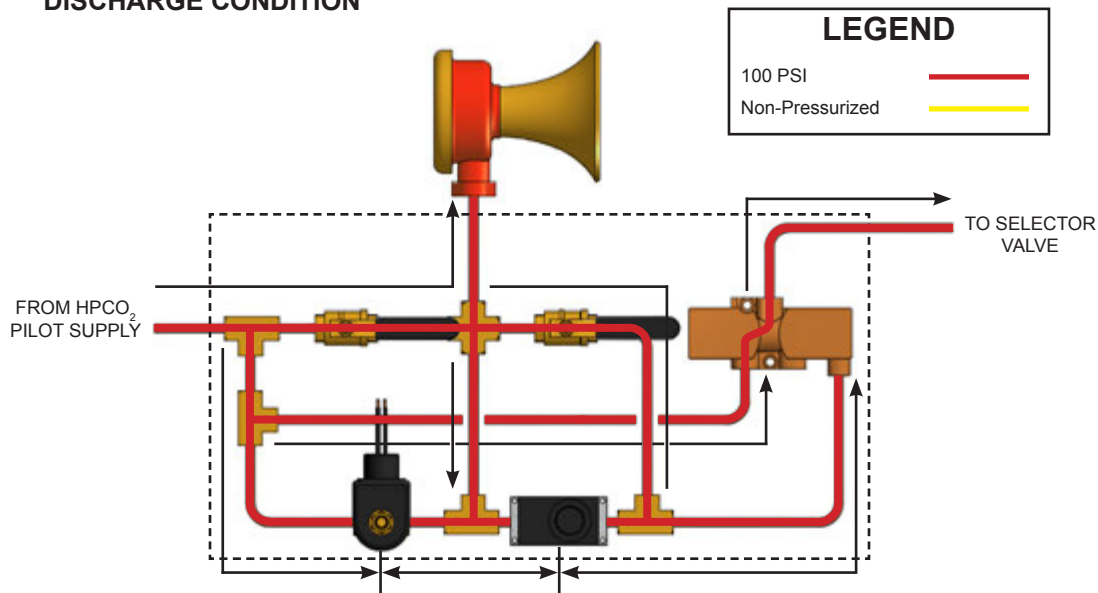

Manually Actuated Cabinet (Timer Bypass)

Note: The HPCO₂ primary cylinder manual actuators operate independently of the pilot cabinet. Actuation must occur at both locations to manually actuate the system.



DISCHARGE NOZZLES

Various nozzle options are available depending on the application and hazard requirements.

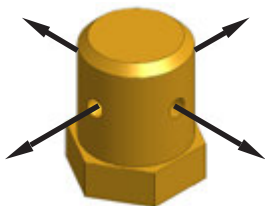

360° Radial Nozzle (4 Port)

360° radial nozzles are used for total flooding application. These nozzles are placed in the middle of a hazard space and discharge CO₂ agent in four directions allowing for a 360° coverage area. Nozzles are available in brass or stainless steel with seven different pipe sizes.

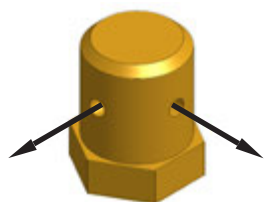

180° Sidewall Nozzle (2 Port)

180° sidewall nozzles are used for total flooding application. These nozzles are placed against the wall or edge of a hazard space and oriented to discharge CO₂ agent in two directions allowing for a 180° coverage area. Nozzles are available in brass or stainless steel with seven different pipe sizes.

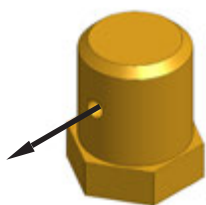

90° Corner Nozzle (1 Port)

90° corner nozzles are used for total flooding application. These nozzles are placed in the corner of a hazard space and oriented to discharge CO₂ agent in one direction allowing for a 90° coverage area. Nozzles are available in brass or stainless steel with seven different pipe sizes.

Nozzle Orientation Part Number						Nominal Pipe Size
Brass			Stainless Steel			
360°	180°	90°	360°	180°	90°	
18508	18501	18494	18797	18790	18783	1/2 in (15 mm)
18509	18502	18495	18798	18791	18784	3/4 in (20 mm)
18510	18503	18496	18799	18792	18785	1 in (25 mm)
18511	18504	18497	18800	18793	18786	1-1/4 in (32 mm)
18512	18505	18498	18801	18794	18787	1-1/2 in (40 mm)
18513	18506	18499	18802	18795	18788	2 in (50 mm)

Ordering Instructions: Specify the Nozzle P/N followed by a dash and the three digits representative of the drill code as provided by the Janus Design Suite software.

Example: 18508-XXX = Nozzle: 360°, 1/2" (15 mm), Brass (with drill code as specified)

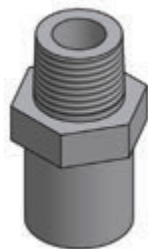

Orifice Nozzle



Orifice Nozzle with Check

Orifice Nozzles

Stainless steel orifice nozzles are used for total flooding application. These nozzles are used for smaller hazard areas where a small flow rate is required. Orifice nozzles with protective checks are also available to protect against particulates in protected space entering or clogging pipe. Nozzles with protective check have a metal-to-metal seat for extreme temperature ranges [-320°F to 400°F (-195.6°C to 204.4°C)] or a Buna N seat for bubble tight installation [-65°F to 250°F (-53.9°C to 121.1°C)].

P/N	Type	Pipe Connections
19372	Orifice Nozzle, No Check	1/2 in (15 mm) MNPT x 1/2 in (15 mm) FNPT
97991	Orifice w/ Check, Metal-to-Metal Seat	1/2 in (15 mm) FNPT Inlet, 3/4 in (20 mm) MNPT Outlet
97578	Orifice w/ Check, Buna N Seat	1/2 in (15 mm) FNPT Inlet, 3/4 in (20 mm) MNPT Outlet

Ordering Instructions: Specify the Nozzle P/N followed by a dash and the three digits representative of the drill code as provided by the Janus Design Suite software.

Example: 97991-XXX = Nozzle, Orifice w/ Protective Check, Metal-to-Metal Seat (with drill code as specified)

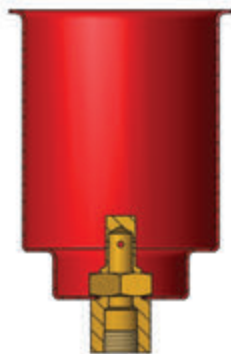

JLA Nozzles

Janus Local Application (JLA) nozzles may be used for total flooding application, but are the only nozzle suited for local application. For local application, JLA nozzles are placed a specific distance from the protected hazard to discharge directly onto that hazard. Nozzles are available with painted cones and brass jet tip nozzles or with stainless steel cones and stainless steel jet tips. 1/2" (15 mm) or 3/4" (20 mm) pipe sizes are available.

P/N		Nominal Pipe Size	Nominal Cone Size
Painted	SST		
19382	19650	1/2 in (15 mm)	4 in (100 mm)
19383	19651	3/4 in (20 mm)	4 in (100 mm)
19384	19652	1/2 in (15 mm)	6 in (150 mm)
19385	19653	3/4 in (20 mm)	6 in (150 mm)

Ordering Instructions: Specify the Nozzle P/N followed by a dash and the three digits representative of the drill code as provided by the Janus Design Suite software.

Example: 18382-XXX = Nozzle, JLA, 4", 1/2" NPT, Painted (with drill code as specified)

SUPPLEMENTAL COMPONENTS

Supplemental components complete various system arrangements.

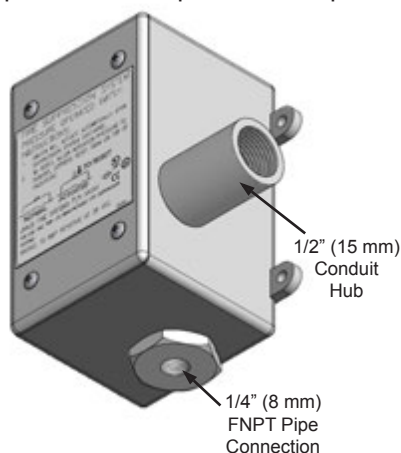

Discharge Pressure Switch (P/N 18773)

The discharge pressure switch is used in the system to provide positive indication of agent discharge and to initiate the shut down of equipment that may deplete agent concentration. The pressure switch is a single pole, double throw (SPDT) switch with contacts rated 10 Amps resistive at 30 VDC.

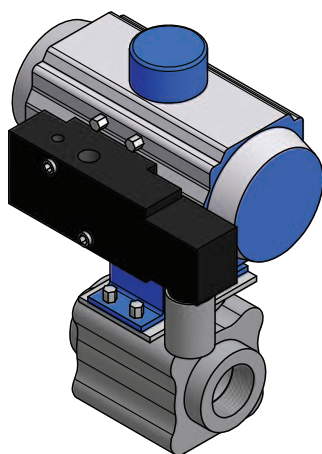

Selector Valve

Selector valves are used in specific cylinder arrangements to allow the protection of multiple hazards or hazard zones by one set of HPCO₂ cylinders or where a time delay is required. Janus Fire Systems[®] HPCO₂ selector valves are available as various sized (1/2 in, 3/4 in, 1 in, 1-1/2 in, 2 in) pneumatically actuated ball valves or a 3 in (80 mm) pneumatically actuated wafer valve. Optional solenoid is available. Refer to DS1093 for part numbers, specifications, and ordering information.

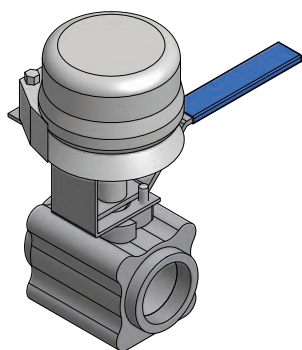

Lockout Valve

Lockout valves are used in specific cylinder arrangements where manual isolation of pipe is required. Janus Fire Systems[®] HPCO₂ lockout valves are available as various sized (1/2 in, 3/4 in, 1 in, 1-1/2 in, 2 in) manually actuated ball valves or a 3 in (80 mm) manually actuated wafer valve. Optional stem extension and explosion-proof limit switch are available. Refer to DS1092 for part numbers, specifications, and ordering information.

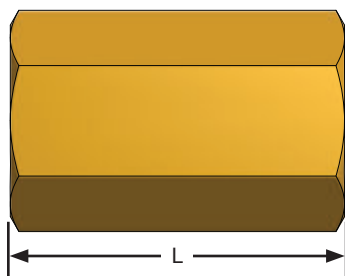

Inline Check Valve (P/N See Chart)

In a main / reserve or initial / extended arrangement that shares a common manifold, inline check valves are required. These check valves have a maximum pressure of 3000 psig @ 70°F (206 bar @ 21°C). Inline check valves are available in five different sizes and are made of either brass or stainless steel.

Inline Check Valves							
P/N		Valve Size (FNPT)		Length (L)		Weight	
Brass	Stainless Steel	in	mm	in	mm	lbs	kg
19501	19507	1/2	15	2.71	69	0.6	0.3
19502	19508	3/4	20	2.94	75	0.7	0.3
19503	19509	1	25	3.64	92	1.4	0.6
19504	19510	1-1/2	40	4.37	111	3.9	1.8
19505	19511	2	50	5.85	149	5.8	2.6
19506	19512	3	80	6.25	159	16.4	7.4

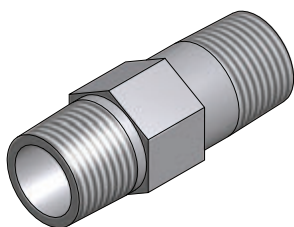

Inline Check Valve (P/N See Chart)

These check valves have a maximum pressure of 3000 psig @ 70°F (206 bar @ 21°C) and are available in two different sizes and made of brass or stainless steel.

Inline Check Valves							
P/N		Valve Size (MNPT)		Length		Weight	
Brass	Stainless Steel	in	mm	in	mm	lbs	kg
19475	19476	1/4	8	1.62	41	0.4	0.2
19477	19375	1/2	15	2.28	58	0.6	0.3

Regulator (P/N 19599)

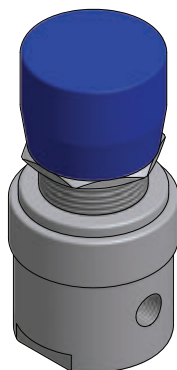

A 316L stainless steel self-relieving pressure regulator with Teflon seat is utilized to regulate pressure to the pneumatic pilot cabinet or pneumatic actuation ports of selector valves. It has a 1/4 in (8 mm) FNPT inlet and outlet with a maximum operating inlet pressure of 3600 psig (248 bar) and an outlet range of 0 to 250 psig (0 to 17.2 bar). It is normally set to 100 psi (6.89 bar). The regulator has a standalone ambient temperature range of -40° to 500°F (-40° to 260°C) and a Cv of 0.5. A standalone pressure gauge (P/N 19171) can be installed immediately downstream of the regulator to verify pressure settings.

Vent Check (P/N 10173)

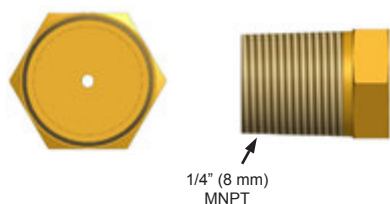

Vent checks are used in the manifolds of main/reserve systems as well as in the manifolds of systems that have selector valves. When one bank of cylinders discharges, the vent check vents any accidental check valve leakage that could discharge the other bank or banks of cylinders. The vent check is normally open with a ball seal that closes when manifold pressure reaches approximately 20 psi (1.4 bar) to prevent loss of CO2 under normal discharge conditions. The pipe connection is 1/4 in (8 mm) MNPT.

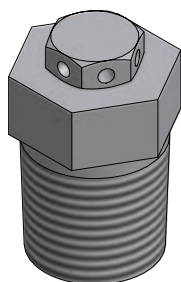

Manifold Header Safety (P/N 19598)

This pressure relief device is installed in sections of closed piping such as between selector valves or lockout valves and the cylinder manifold. It is a frangible disc assembly designed to rupture if trapped CO2 expands and the line pressure exceeds 2,650 to 3,000 psi (182.7 to 206.8 bar). The body is made of brass and the pipe connection is 1/2 inch (15 mm) MNPT.

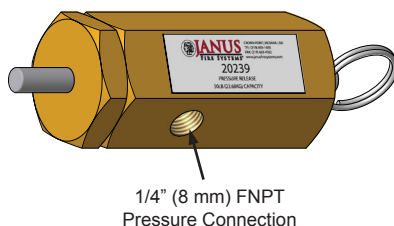
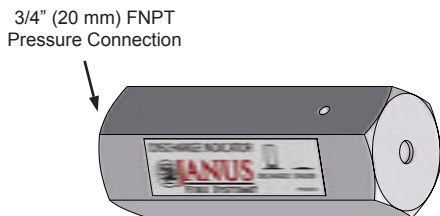
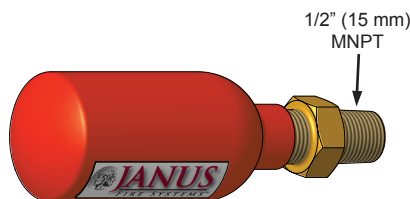
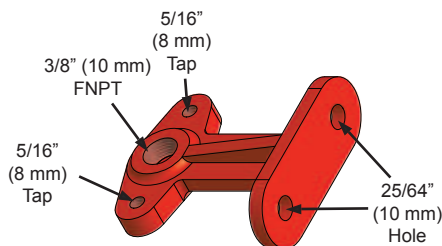
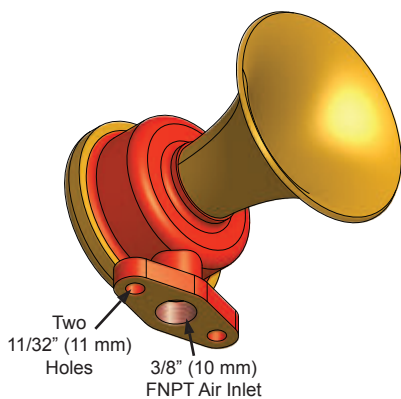

Pneumatic Siren (P/N 19224)

A pneumatic siren is installed downstream of each pneumatic pilot cabinet so that it is sounded during the pre-discharge period as required by NFPA 12. Each siren has a solid cast bronze bell with a stainless steel diaphragm and reaches a sound level of 119 ± 1 DBA @ 100 psi at 10 ft (3.05 m). Each siren uses 1.3 lbs/minute (0.49 kg/minute) and has a C_v of .25. The sirens have an operating pressure of 50 to 150 psi (3 to 10 bar) and a stand-alone ambient temperature range of -4° to 400°F (-20° to 204°C).

Pneumatic Siren Bracket (P/N 19225)

A pneumatic siren bracket affixes to the base of each pneumatic siren to allow the siren to be fastened to an outside surface.

Odorizer Assembly (P/N 99703)

The odorizer assembly is installed into system piping to provide an olfactory indication of system actuation. During system discharge, a frangible disc inside the odorizer assembly ruptures, allowing wintergreen contained in the odorizer body to mix with the discharging agent. This causes the normally odorless carbon dioxide agent released into the protected hazard to possess a distinct wintergreen smell. The odorizer assembly is non-refillable.

Discharge Indicator (P/N 20238)

The discharge indicator acts as a nonelectrical visual indicator of system actuation. It is actuated through discharge pressure and remains in the upright (discharged) position until manually reset.

Pressure Trip Release (P/N 20239)

The pressure release trip can be used to release dampers, close fire doors, windows, louvres, fuel supply valves, to open dump valves, etc., automatically when the system discharges. The equipment to be operated must be weight or spring loaded, or be pivoted off center. The release trip is connected to the carbon dioxide discharge piping for operation when the system discharges. A cable from the equipment to be controlled is looped over the pressure release operating stem. When the trip is operated, the stem retracts and the cable is released. The maximum load that can be hung on the piston stem is 35 lbs (15.88 kg).

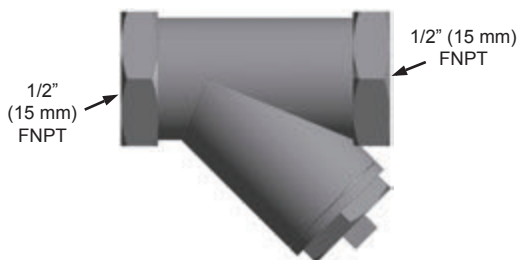

High-Pressure Y Strainer (P/N 98656)

A strainer is used upstream of the pressure regulator to prevent damaging contaminants from entering the regulator and pilot line. The “Y” pattern design and generous screen area function to minimize initial pressure drop while maximizing time between cleaning. The strainers are A351-CF8M stainless steel and are provided with a 40 mesh lining. The connections are FNPT for each respective size. Strainer rating is ASME class 1500. Drain/blow off connection is furnished with a plug.

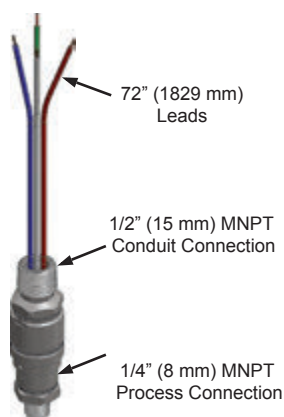

Explosion-Proof Pressure Switch, Self-Restoring (P/N 97430)

A NEMA 4X, 7, 9 and IP 67 Explosion-Proof Discharge Pressure Switch can be used in potentially explosive atmospheres to send indication of agent discharge to a releasing panel and/or initiate the shut down of equipment that may deplete agent concentration. It is a self-restoring double pole, double throw (DPDT) switch with contacts rated 5 Amps at 125/250 VAC and 28 VDC resistive. It is factory set at 50 psig (3.44 bar) rise.

Explosion-Proof Ratings:

- Class I Div 1 Groups A, B, C, & D
- Class II Div 1 Groups E, F, & G
- T5 or T6
- II 2GD
- Ex d IIC T6/T5 Gb
- Ex tb IIIC T85°C/100°C Db
- T5 or T6

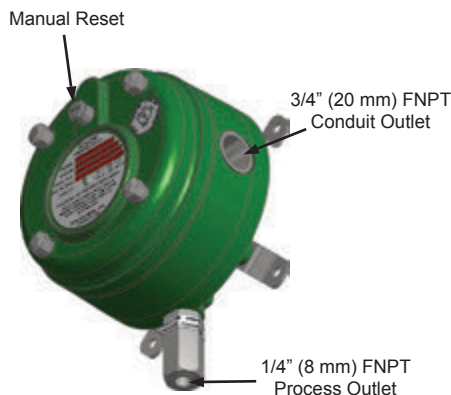

Explosion-Proof Pressure Switch, Manual Reset (P/N 97429)

A NEMA 7 and 9 Explosion-Proof Discharge Pressure Switch can be used in potentially explosive atmospheres where manual reset is required to send indication of agent discharge to a releasing panel and/or initiate the shut down of equipment that may deplete agent concentration. It has two tandem double pole, double throw (DPDT) switches operating in parallel with contacts rated 15 Amps at 125/250/480 VAC and 0.5 Amps at 125 VDC. It is factory set at 50 psig (3.44 bar) rise.

Explosion-Proof Ratings:

- Class I Groups C & D
- Class II Groups E, F, & G



WARNING SIGNS

NFPA 12 mandates the placement of specifically designed warning signs in and around areas protected by CO₂ fire extinguishing systems. Each sign is 6-1/2 in x 12 in (165 mm x 305 mm).

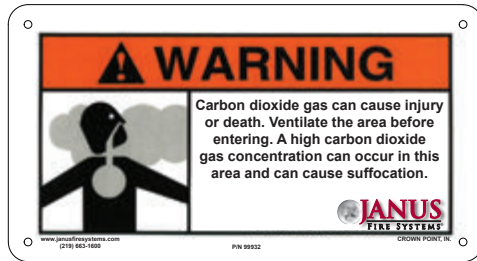

Warning – Storage – P/N 99932
Post sign outside each entrance to carbon dioxide storage rooms.

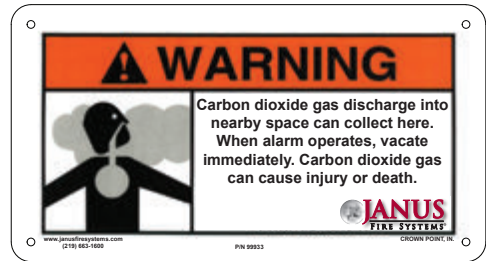

Warning – Nearby – P/N 99933
Post sign in every nearby space where carbon dioxide can accumulate to hazardous levels.

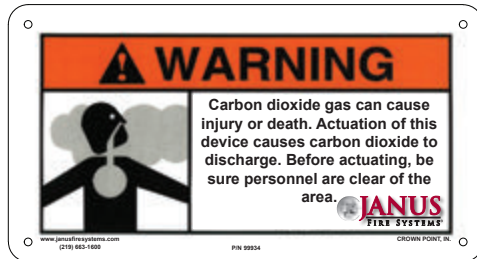

Warning – Manual Actuation – P/N 99934
Post sign at each manual actuation station.

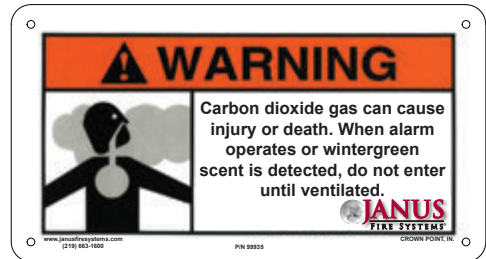

Warning – Wintergreen – P/N 99935
Post sign at every entrance to protected space for systems provided with wintergreen odorizer.

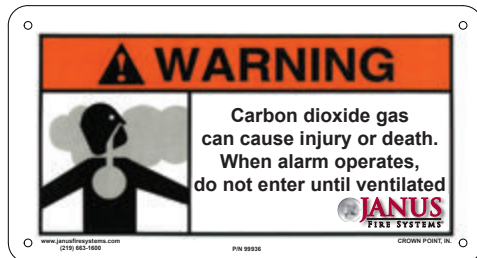

Warning – Entrance – P/N 99936
Post sign in every protected space.

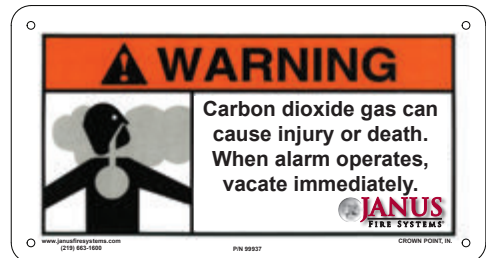

Warning – Exit – P/N 99937
Post sign at every entrance to protected space.

CO₂ CHEMICAL PROPERTIES

CO₂ is a naturally occurring gas found readily in the atmosphere formed from oxygen and carbon molecules. Under normal conditions, CO₂ is an odorless, colorless gas with a density about 50 percent greater than the density of air. The primary extinguishing mechanism of CO₂ is oxygen depletion.

CO₂ leaves no residue and is electrically non-conductive.

SAFETY CONSIDERATIONS

NFPA 12 generally does not permit total flooding CO₂ systems in areas that are normally occupied. Section 4.1 of NFPA 12 should be referred to for exceptions to this.

Inhaling large concentrations of CO₂ causes rapid circulatory insufficiency leading to coma and death. Asphyxiation is likely to occur before the effects of carbon dioxide overexposure. Chronic, harmful effects are not known from repeated inhalation of low concentrations. Low concentrations of carbon dioxide can cause increased respiration and headache.

CO₂ may cause frostbite-like symptoms if liquid discharge or escaping vapor contacts the skin.

The CO₂ Material Safety Data Sheet (MSDS) should be read and understood prior to working with the agent.

A cylinder containing CO₂ should be handled carefully. **The anti-recoil safety plugs must be in place at all times when the cylinder is not connected to the discharge piping.**



Order Review List		
P/N	Description	Nominal Ship Wt. lb (kg)
19561	Cylinder Assembly, HPCO2, 50 lb	146 (66.2)
19560	Cylinder Assembly, HPCO2, 75 lb	235 (106.6)
19559	Cylinder Assembly, HPCO2, 100 lb	310 (140.6)
19589	Actuator, Manual Valve, HPCO2 (primary cylinder)	1.1 (0.5)
19585	Valve Kit, Solenoid, 24VDC, HPCO2 (primary cylinder)	4.1 (1.9)
99733	Valve Kit, Solenoid, 24VDC, XP, HPCO2 (primary cylinder)	4.1 (1.9)
99706	Hose, Flex, Discharge w/ Outlet Check Valve	3.6 (1.6)
99707	Hose, Flex, Discharge w/ Discharge Outlet Adapter	3.4 (1.5)
18773	Switch, Discharge Pressure	1.4 (0.6)
19501	Valve, Check, 1/2" FNPT, Brass <i>Inline Check Valve</i>	0.6 (0.3)
19507	Valve, Check, 1/2" FNPT, SST <i>Inline Check Valve</i>	0.6 (0.3)
19502	Valve, Check, 3/4" FNPT, Brass <i>Inline Check Valve</i>	0.9 (0.4)
19508	Valve, Check, 3/4" FNPT, SST <i>Inline Check Valve</i>	0.9 (0.4)
19503	Valve, Check, 1" FNPT, Brass <i>Inline Check Valve</i>	1.5 (0.7)
19509	Valve, Check, 1" FNPT, SST <i>Inline Check Valve</i>	1.5 (0.7)
19504	Valve, Check, 1-1/2" FNPT, Brass <i>Inline Check Valve</i>	4.1 (1.9)
19510	Valve, Check, 1-1/2" FNPT, SST <i>Inline Check Valve</i>	4.1 (1.9)
19505	Valve, Check, 2" FNPT, Brass <i>Inline Check Valve</i>	6.0 (2.7)
19511	Valve, Check, 2" FNPT, SST <i>Inline Check Valve</i>	6.0 (2.7)
19506	Valve, Check, 3" FNPT, Brass <i>Inline Check Valve</i>	16.6 (7.5)
19512	Valve, Check, 3" FNPT, SST <i>Inline Check Valve</i>	16.6 (7.5)
19475	Valve, Check, 1/4" MNPT, Brass <i>Inline Check Valve</i>	0.4 (0.2)
19476	Valve, Check, 1/4" MNPT, SST <i>Inline Check Valve</i>	0.4 (0.2)
19477	Valve, Check, 1/2" MNPT, Brass <i>Inline Check Valve</i>	0.6 (0.3)
19375	Valve, Check, 1/2" MNPT, SST <i>Inline Check Valve</i>	0.6 (0.3)
10173	Vent Check	0.2 (0.1)
19599	Regulator	1.9 (0.9)
19171	Gauge, Pressure, 1/4 Inch (8 mm) MNPT, 0-160 PSIG, 2-1/2 Inch Dial	0.4 (0.2)
98656	Strainer, 1/2 Inch (15 mm) FNPT, Y, 40 Mesh, SST, Class 1500#	2.4 (1.1)
19598	Device, Header Safety, 1/2" MNPT <i>Manifold Header Safety</i>	0.8 (0.4)
18846	Station, Main/Reserve Transfer, MRS-1, Indoor	1.2 (0.5)
19224	Siren, CO2, 3/8" FNPT	3.1 (1.4)
19225	Bracket, T, CO2, Siren	0.9 (0.4)
99703	Odorizer Assembly	3.1 (1.4)
20238	Indicator, Pressure, Discharge	2.0 (0.9)
20239	Trip, Pressure Release (<i>Pressure Trip Release Mounting Bracket Kit P/N 99702</i>)	2.0 (0.9)
Various	Nozzles — <i>VARIOUS TYPES</i>	Various
Various	Sign, Warning, CO2 — <i>VARIOUS TYPES</i>	0.2 (0.1)

Note: Refer to DS1092 and DS1093 for selector and lockout valve ordering information.

The seller makes no warranties, express or implied, including, but not limited to, the implied warranties of merchantability and fitness for a particular purpose, except as expressly stated in the seller's sales contract or sales acknowledgment form. Every attempt is made to keep our product information up-to-date and accurate. All specific applications cannot be covered, nor can all requirements be anticipated. All specifications are subject to change without notice.



1102 Rupcich Drive
 Millennium Park
 Crown Point, IN 46307
 TEL: (219) 663-1600 FAX: (219) 663-4562
 e-mail: info@janusfiresystems.com
 www.janusfiresystems.com